

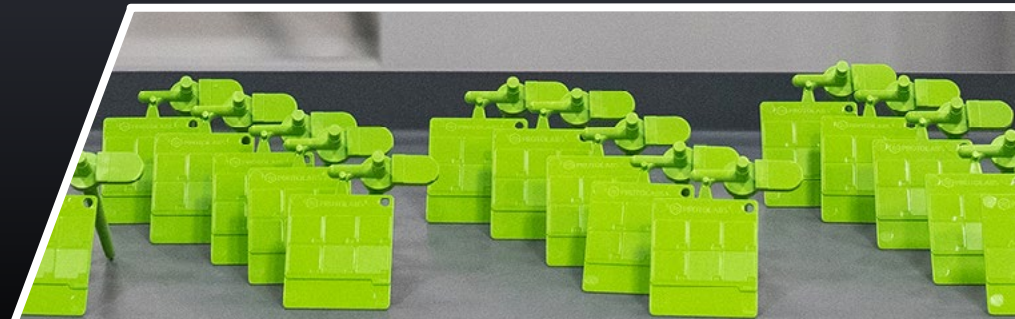

# Definitive Guide to Injection Molding

Leveraging Digital Manufacturing  
to Optimize Design and Process



# Contents

One of the most interesting features of injection molding is how easy it appears to the untrained observer. But the depth of engineering knowledge needed to design molds that allow just the right amount of resin to flow smoothly to make all the features of your part, while not sticking to the mold, cannot be underestimated. This guide offers a comprehensive look at injection molding, from design to quoting to production.

**03** Why Automation Means Everything

**04** Getting a Quote with DFM Analysis

**08** Design for Moldability

**12** Material Selection

**17** Designing for Liquid Silicone Rubber Molding

**22** Finishing Options for Molded Parts

**27** Process Controls, Quality Assurance, and Reporting

**30** Prototyping to Production

**32** Why Injection Molding at Protolabs?



# Why Automation Means Everything

Injection molding itself isn't incredibly complex. You heat up pelletized plastic material until it becomes molten, and then you inject it through a heated nozzle at high pressure to fill a cavity. From there, it's kind of like making a waffle in a waffle iron. Although the techniques we use today first emerged in the late 1800s, the processes have been refined and improved over time.

More importantly, they are now driven by automated systems at digital manufacturers like Protolabs to create a continuous digital thread running from quoting to production to shipping.

In traditional injection molding, the process of determining the suitability of molded parts (also known as designing for manufacturability or DFM) is a manual process completed by a molding engineer. With traditional molding shops, this DFM review happens after a purchase order has been sent. This is inherently risky as changes to a part design at this stage of the process can have downstream effects that affect the rest of the project or assembly. The processes we use today to design parts suitable for injection molding, or design the components of the mold itself, are significantly more complex.

At Protolabs, we rely on software, automation, and standardization to reduce these risks. When we receive a 3D CAD model to quote, software analyzes that model and compares it to the standardized and fixed

toolset that we use for creating molds. We are not only evaluating basic mold design elements—parting lines, gates, ejector layouts—but we are determining exactly what endmills and toolpaths will be required to machine the mold. The DFM analysis provides feedback on elements within the geometry that might be difficult to mold or could affect the cosmetics or dimensional results of the molded component. Essentially, we are digitally manufacturing every part that comes through our system before the quote is sent back to the customer—creating a digital twin.

This digitalization of the quoting and manufacturing process has several benefits. Because we are providing DFM at the time of quote, it enables engineers to incorporate design changes upfront and optimize parts before any production begins. The result? Parts that are well-designed for the injection molding process. Since the mold design is done simultaneously with quoting and not after the order is placed, we quickly and confidently transition from quote to production, saving time and reducing the risk that exists in the traditional manufacturing environment.

In this guide, you'll find examples and strategies to better leverage digital manufacturing technologies and the injection molding process. With these tools, we hope to make your next molding project your best one yet!



# Getting a Quote with DFM Analysis

When you're manufacturing molded parts, the last thing you need is a design that isn't moldable—or worse—finding out you need to change your design after manufacturing has already started. Quoting should be complete, sensible, and provide you with the kind of feedback you need to get the parts you want quickly and to spec.

Here's a quick tour of our platform, highlighting some of the key features around navigation, organization, collaboration, and other elements.

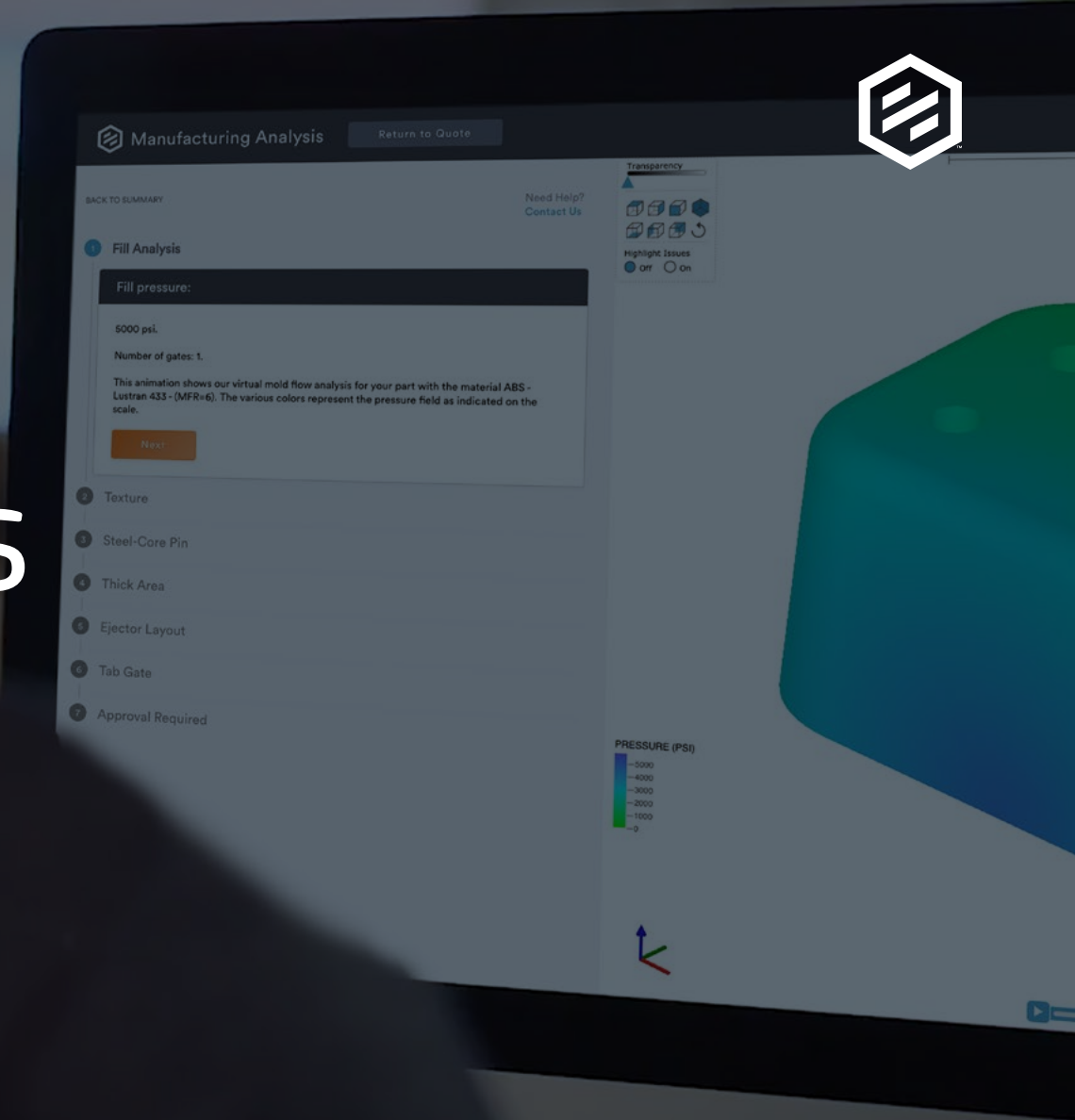

# Navigation

## Sign In

Just hit **GET A QUOTE** in the upper right corner on any protolabs.com page or **SIGN IN** to your account directly above it. From there, you can either quickly create a new account—we just need a few pieces of information—or sign in to your existing Protolabs account. After your first sign in, we'll remember your info for future visits for easy one-click sign in.

## Start a Project

Once signed in, you'll arrive at your **PROJECTS** page. Just hit **CREATE A NEW PROJECT**. Then, give it a memorable name. Once that's done, click to **CREATE A NEW QUOTE**. Choose injection molding for molded parts.

## Upload a Part

Pretty easy so far, right? Now it's time to upload one (or multiple) 3D CAD files, which you can do by browsing your saved files or simply drag-and-drop.

## Configure Your Part Quote

Now that you've uploaded your CAD file(s) to your project, just hit **CONTINUE** to start configuring your parts. You can include details like material selection, part quantity, finish, service-specific options, and things like ITAR requirements and special instructions. When you're all set, click **ANALYSIS**. You'll receive an interactive quote with free, automated manufacturing analysis—often within 20 minutes.

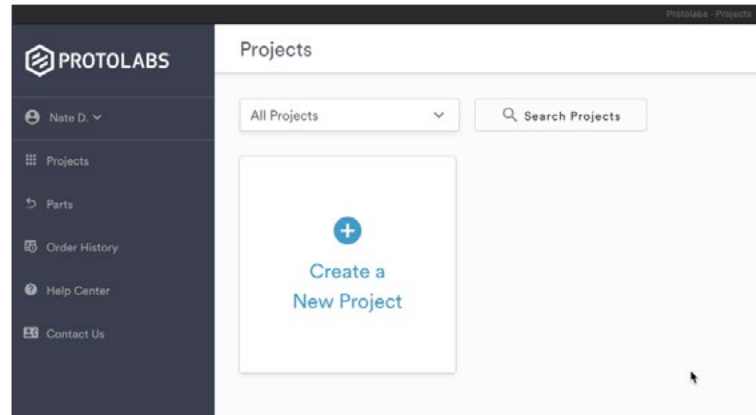

Once you've signed in to our e-commerce system and are ready to start a new project, just hit **CREATE A NEW PROJECT**.

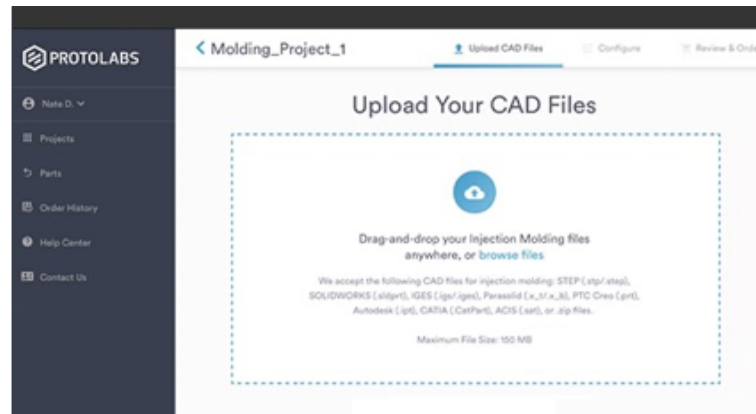

Upload one or multiple 3D CAD files by browsing your saved files or via our drag-and-drop interface as seen here. We accept a number of file formats (see list on right).

## We accept these types of files:

- ▶ IGES (.igs)
- ▶ STEP (.stp)
- ▶ SolidWorks (.sldprt)
- ▶ PTC Creo (.prt)
- ▶ Parasolid (.x\_t and .x\_b)
- ▶ ACIS (.sat)
- ▶ AutoCAD (.dwg, 3D only)
- ▶ Autodesk Inventor (.ipt)
- ▶ CATIA (.CatPart)
- ▶ Compressed folders (.ZIP) can contain any combination of the above model file types
- ▶ STL (.stl)

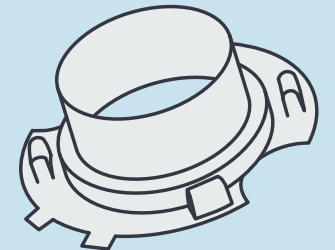



# Critical-to-Quality

Critical-to-Quality (CTQ) is a feature of our process that allows you to identify up to five critical features or dimensions of importance to your part functionality and performance, including several Geometric Dimensioning and Tolerancing (GD&T) features. It is included for all on-demand manufacturing mold orders. You'll get a three-piece FAI report and a 30-piece capability report, too. Submit a print of your model and use a red circle to indicate those critical features.

If we can't solve issues involving tolerances for any of these without affecting your experience or lead time, we will reach out and let you know about other options available to meet your needs.

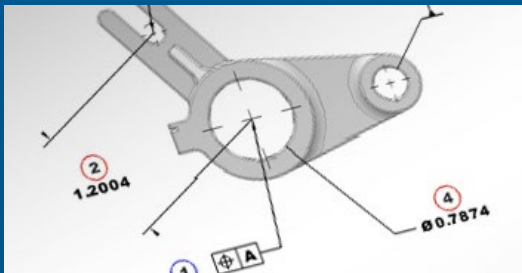

## Review Your Order

Soon, your inbox will have an email from us that allows you to jump back into your project to **REVIEW & ORDER** your quoted parts. You now have real-time pricing and manufacturing analysis based on your selections. If you want to adjust part quantity and shipping—no problem. Updated pricing will be reflected in your quote.

There's even a Receive By calendar. Just choose the date you want to receive parts and see any cost implications. We also provide complete shipping costs and tax at checkout, not after. This means no hidden fees, so your quote is an accurate and trustworthy pricing statement. You can even share your quotes with colleagues or procurement teams.

But before checking out and ordering parts, we need to visit the heart of our platform—the automated manufacturing analysis.

## Manufacturing Analysis

Simply stated, our manufacturing analysis provides feedback on the geometry of your CAD file to improve manufacturability. At the bottom of your quote review, you might notice small green, yellow, and red icons. The colors differ depending on the attention needed. Green? You're good to go. But if you see yellow or red advisory icons, you'll need to hit the **VIEW ADVISORIES** button to review the design feedback.

We look at draft, wall thickness, and other variables, and highlight the ones that are potentially troublesome. Any recommended changes are optional but are suggested to improve manufacturability.

Any required changes mean you'll need to update your part geometry based on the feedback and upload a new CAD file to proceed with your order. In some cases, we may even provide a proposed revision that you can accept (or decline) to accelerate the ordering process. If you have other questions about our feedback, go on a [manufacturing analysis deep dive](#).

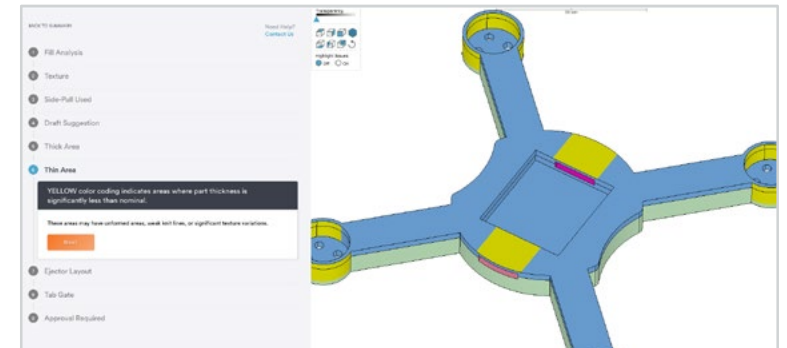
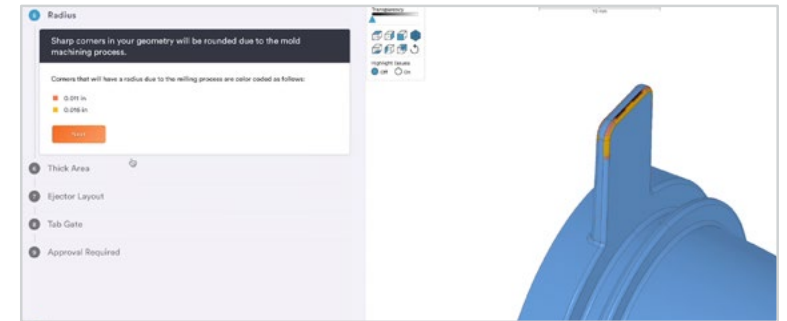

[Upload a 3D CAD model](#) today for an interactive quote with manufacturing analysis—within hours.



## Consultative Design Service

What happens when your CAD model doesn't quite meet our guidelines? That's where our Consultative Design Service (CDS) comes in. [CDS](#) helps you update your CAD model to address the manufacturability feedback you received with your quote. One of our experienced applications engineers will work with you on your part design to improve manufacturability and ensure your part is moldable. CDS addresses these issues at the beginning of the quoting process, accelerating ordering, production, and speed to market.

### Checkout

Once your part design is optimized and any modifications addressed, and your pricing and shipping details are in order, just hit **CHECKOUT NOW** in the **REVIEW & ORDER** page. Plug in shipping (add reference number, drop ship address, export docs) and billing info (pay with CC or PO), confirm the details, and hit **COMPLETE ORDER**. Depending on your chosen ship date, parts can be sent out in as fast as 24 hours and in your hands soon after.

The screenshot shows a checkout form with three main sections: 1. Shipping, 2. Billing, and 3. Review. The Shipping section includes fields for 'Shipping To (Change)', 'State Center - Puchinda', '5540 Pioneer Creek Dr.', 'Maple Park, MN 55359', 'United States of America', and '5675 479-3880'. It also has options for 'Use My Client Account' and 'Add a Reference Number'. The Billing section has radio buttons for 'Pay with Card' and 'Pay with Purchase Order (PO)'. Below that is the 'Billing Address (Change)' section with the same address and phone number as the shipping section. There is a 'Purchase Order Number (Change)' field with '6530' entered. At the bottom, there is a 'Purchase Order File' section with a note: 'Please attach to send purchase orders, or upload now.' The Review section has a note: 'By clicking Complete Order, you agree with our Terms and Conditions of Sale.' and a large orange 'Complete Order' button.

Ultimately, things have been engineered to improve your entire buying experience. Next, here are a few things around organization and collaboration that we want to touch on before wrapping up.

### Organization + Collaboration

If you enjoy a neat, clean, and orderly user interface, we've got some good news. When you have an account and start creating projects, requesting quotes, and ordering parts, you can organize your account by projects and build a parts library.

Have more parts to upload for quoting? As touched on earlier, you can load and configure multiple parts from multiple services—molding, machining, and 3D printing. Again, this helps maintain order. Have an expired quote? No worries. You can easily access quotes that have expired and immediately re-price them.

Searching for quotes and orders is painless via the search bar inside your **PROJECTS** page and in your Order History. Accessing the previously mentioned manufacturing analysis that has been provided on quotes is seamless—find it right within your corresponding project. If you're supplying your own resin—you can manage that, too.

We all know that teamwork makes the dream work, so let's close with a few collaboration tools available for you. We've added a **FORWARD QUOTE** function that lets you easily share quotes with collaborators like colleagues, managers, and procurement teams. Collaborators can adjust turn time, materials, finishing, and other options to see real-time pricing impact.

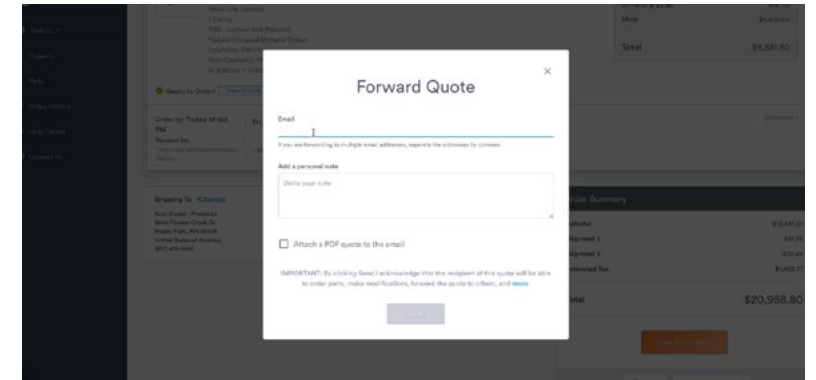

There you have it. If you're a returning customer—thank you for your business, and we hope you love our user-friendly interface. If you're a new customer who has ordered from other manufacturing platforms before, we think you're in for a treat.



# Design for Moldability

We mentioned it earlier: Designing molded parts may seem easy at first—plastic resin is heated, then injected into an empty cavity. Simple, right? In truth, there are lots of ways your designs can get tripped up, and many issues may emerge from designs that fail to consider manufacturability.

It almost goes without saying that it's important to consider the end-use purpose of given parts and the environment in which they will be used. That necessitates thinking about the material you should choose even before you ponder design.

This chapter focuses on the dos and don'ts of designing for manufacturability (DFM).

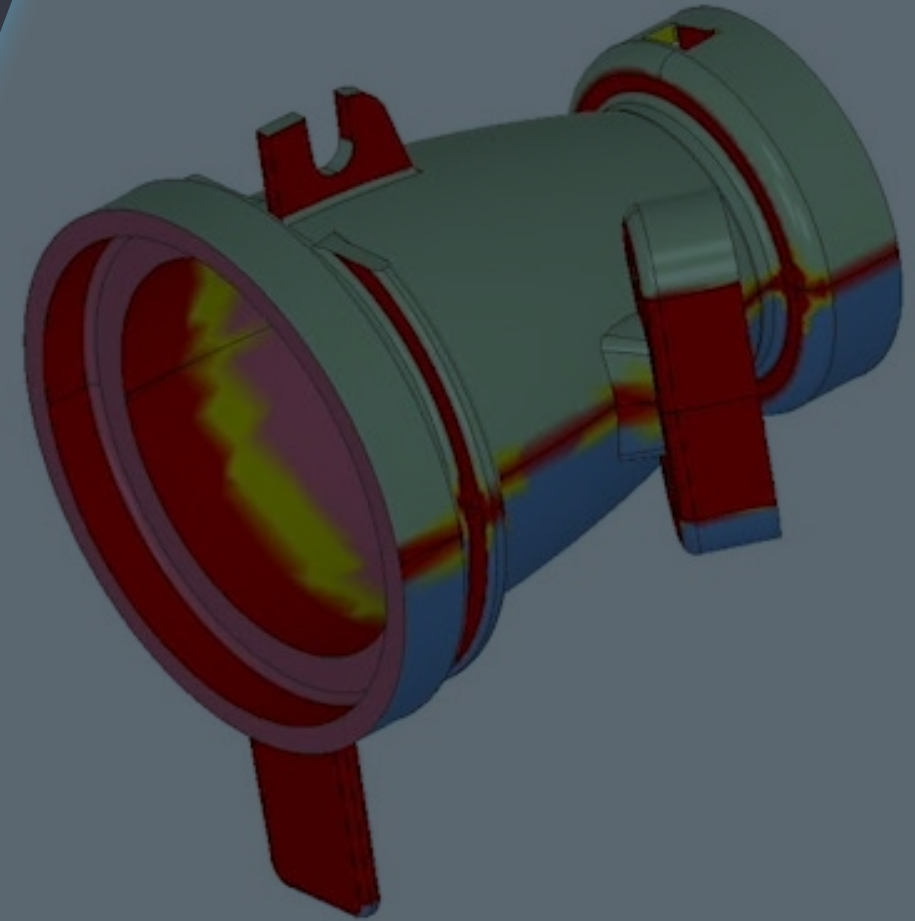



# 8 Moldability Mistakes to Avoid

## 1 Add Sufficient Draft to Parts

Adding draft angles to your design ensures that your part can be removed easily from the mold. It also improves overall moldability. But how much draft is just right? When we make our molds, whether aluminum or steel, we use high-speed CNC milling. As general rule of thumb, use 1-degree of draft per inch of depth, and don't forget to leave enough thickness to allow for cutter penetration.

## 2 Avoid Non-Uniform Wall Thickness

Having wall thicknesses come as close as possible to uniform will make for a stronger part. Thinner areas will tend to sink and warp. If you need to design thinner walls in places, they should be no less than 40-60% of the width of adjacent walls. And watch out—some materials have quite specific thickness requirements to keep parts strong.

## 3 Transition Gradually from Thick to Thin Areas

No one wants weak, saggy parts. After ejection from a mold, parts must cool. Thin areas will inevitably cool faster than thick ones. That temperature differential can create weak areas, leading to sink and warp. Avoid sharp differences in wall thickness. Instead, create gradual transitions between these areas.

## 4 Consider Carefully Your CAD File Format

Sometimes we get CAD files that were translated from .STL files. Doing this can create problems with molded parts. That's because .STL files render the part's surface as a series of triangles, rather than the true curves you would find on real parts. That makes them harder to quote. Instead, output your designs as STEP files and clearly define thicknesses.

## 5 Use Radii Wisely

Building radii into a part can be a hit or miss proposition. Only use them in necessary areas, for example to eliminate sharp edges that an end user may touch, or in critical functional areas such as a lead-in to an assembly. Often, radii are used on inside corners of critical features to make more robust geometry. They can also help material flow more readily. In general, proper placement of corner radii can create stronger molded parts.

## 6 Be Careful with Parting Lines

Making parting lines as unnoticeable as possible always makes for interesting design and manufacturing challenges. Deciding where to locate them is an exercise filled with aesthetic and mechanical considerations. But watch out. If you try putting a fillet or radius around a parting line, you might end up with undesirable undercuts in your mold and maybe even flash.

## 7 Eliminate Undercuts if Possible

Undercuts make it difficult to eject parts from molds. Sometimes these are created using techniques such as side-action cams or pickout inserts, but that can add manufacturing time due to molding costs and complexity. Whenever possible, eliminate undercuts. More on those later in this chapter.

## 8 Determine if Cosmetic Finishes are Necessary

Cosmetic finishes are possibly the most overlooked piece of the design process. If you don't need them, don't order them. You can always choose to go back later and add cosmetic finishes to future parts. It's yet another way to save yourself some time and expense. Also, don't forget that all-over finishes take longer to, ahem, finish, vs. targeting specific areas.

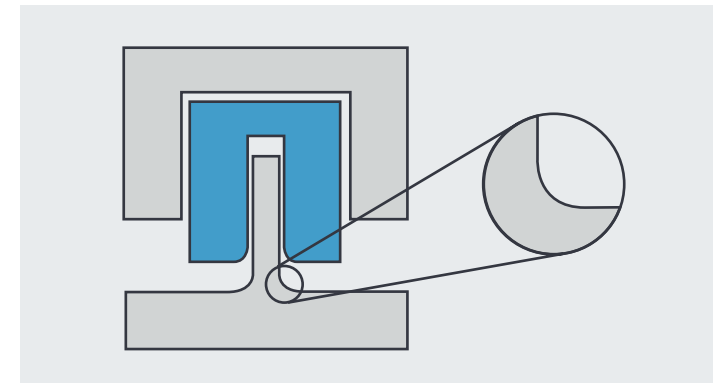

An illustration of a corner with a radius.

## Undercuts, Side-Actions, and Cams

Undercuts are features in an injection-molded part that prevent its ejection from the mold. With straight-pull molds, these are any protrusions, holes, cavities, or recessed areas in the part where alignment is not perpendicular to the mold's parting line (the area where the two sides of a mold meet).

Side-actions are the solution. Basically, when the molding cycle begins, the mold closes and the side action slides on an angled pin at the same rate, so they are sealed shut at the exact same time. Molten plastic is shot into the mold and held for a short time to cool. As the mold opens, cams pull side-action mold surfaces away from undercut features, allowing the part to be released from the mold.

## Pickouts

In some cases, the fastest and most cost-effective solution for undercut features is to machine a custom mold insert called a pickout. These can provide more design freedom than side-action cams since they don't need to align to the mold in any particular way. A common use case for them is a boss feature on an angled surface.

## Bumpoffs

A bumpoff is a small undercut in a part design that can be safely removed from a straight-pull mold without the use of side-actions. Use bumpoffs to solve some slight undercuts but know that they are sensitive to geometry and material type.

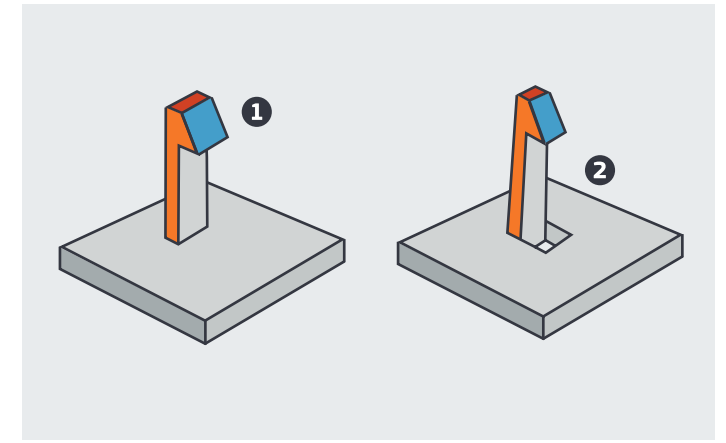

Undercuts, such as those shown, can complicate and, in some cases, prevent part ejection, so eliminate them if possible.

## Helpful Undercut Tips

- 1 Be aware of the impact that undercuts might have on upfront mold investment and long-term product costs. It's not always possible to eliminate them, but your manufacturer's applications engineers should offer some ideas on how to minimize their impact.
- 2 Don't discount secondary operations. Using a drill press or milling machine to put a hole in a molded part is sometimes more cost-effective than designing a complex part requiring a do-everything mold. This is especially true during the prototyping and low-volume production phases of your project.
- 3 Discuss long-term product plans with your manufacturer to help design the most efficient mold for your applications.

# Shutoff Angles

Shutoffs offer an elegant way to simplify mold design and reduce product costs. Just be sure the part and mold have sufficient draft—add a minimum of 3 degrees from vertical, if possible—or else metal-on-metal rubbing might occur, creating flash or premature tool damage. Maintaining a 3-degree shutoff between mold components is critical for long-lasting, robust molds.

# Text/Engraving

To get raised (embossed) text in your part, use engraving in your mold design. The text you mill into the mold will become raised text on your part. Milling the text into your mold is a fast process, leading to faster turnaround times. Also maintain at least a 0.020 in. (0.508mm) stroke width to achieve clean text.

# Multi-Cavity Molds

Moving from a single-cavity mold to one that produces two or more parts at once seems like an easy way to increase production volume and reduce part costs. But the physics encountered when forcing molten plastic through a mold's sprues, runners, and gates change as molds become larger and more complex. That can affect molding performance and part quality. Also, thermal variations within a multi-cavity mold body become more of a concern, and plastic must travel longer distances to reach the finish line, both of which increase the risk of partially filled cavities and sink, as well as part deformation after ejection.

**Optimize your multi-cavity mold design by:**

- ▶ Adjusting the mold gate
- ▶ Using side-actions
- ▶ Including pickouts
- ▶ Using a family mold (more than one part design cut into a single mold)
- ▶ Opting for liquid silicone rubber as your material instead of thermoplastic elastomers

# The Basics of Designing for Molding

When you upload your CAD model online, you'll receive free DFM analysis of your molded part design. Undercut areas will be clearly defined, along with other moldability concerns. On your end, here are the basic must-dos for molding:

- ▶ Parts should have sufficient draft angles to ensure easy part ejection from the mold.
- ▶ Wall thicknesses should be uniform and comply with the resin manufacturer's minimum/maximum thickness recommendations.
- ▶ Ribs should be used to support large flat areas.
- ▶ Internal corners should have radii, and thick sections cored out to prevent sink.
- ▶ Fine finishes should be used only where needed.



[Upload a 3D CAD model](#) today for an interactive quote with manufacturing analysis—within hours.

# Material Selection

When it comes to finding the right material to make your molded parts, working with a manufacturer with a huge selection of options always helps. We offer nearly 100 different plastics and more than 30 in the elastomer and liquid silicone rubber (LSR) families.

Two broad categories of plastic materials exist: thermoplastics and thermosets, which are differentiated based on their behaviors in the presence of heat. One way to explain the difference between the two is to consider an omelet.

Start with an egg, a slice of cheese, and a warm pan. The egg starts as a liquid (actually, a colloid, but let's not quibble) which, when dropped in a warm pan, becomes a solid. The cheese, on the other hand, begins as a solid, but when heated (but not overheated) becomes a viscous liquid.

After heating the egg, you can cool it or reheat it, but it will never return to its liquid state. It remains solid, just as thermoset polymers do. But if you cool the melted cheese, it regains its solid form. Reheat it and it flows again, just like thermoplastics. Now stop reheating it—after a while, it gets kind of gross.

## Guidelines for Using Thermoplastics

Keep in mind that even a well-designed part can fail if manufactured from the wrong material, especially when considering thermoplastic versus thermoset injection molding. So, when selecting materials for injection molding, carefully consider factors such as strength, impact resistance, and performance at high temperatures, among others.

Also, make sure to review properties of common resin types, such as Acetal, Acrylic, high-density polyethylene, polycarbonate (PC), polypropylene (PP), and polystyrene (see table). To take it a step further, consult our [Materials Comparison Guide](#). We also have a more technical [thermoplastic material selection guide](#). If one material doesn't provide everything you need on its own, you may be able to blend them. For example, the table on the next page shows, when polycarbonate and ABS are combined, the new material is stronger and can form a part more accurately than ABS alone.

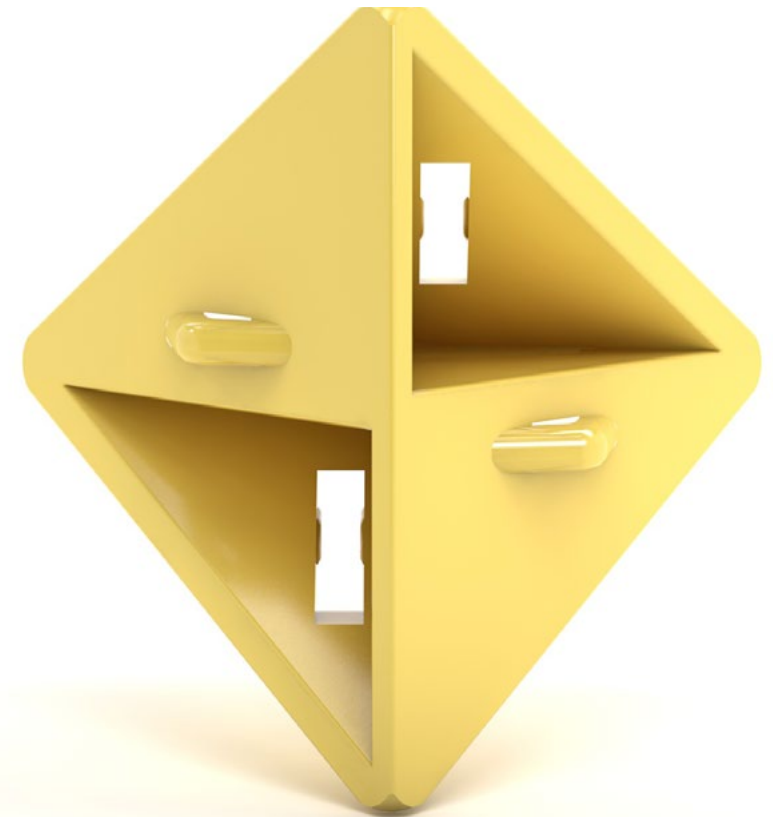

# Materials at a Glance

Resin Type	Strength	Impact Resistance	Dimensional Accuracy	Capability to Fill Small Features	Performance at High Mold Temps	Cost
POM or Acetal (Polyoxymethylene)	Medium	Medium	Fair	Fair	Fair	Low
PMMA or Acrylic (Polymethyl Methacrylate)	Medium	Low	Good	Fair	Good	Low
ABS (Acrylonitrile butadiene styrene)	Low to medium	High	Good	Fair	Good	Low
HDPE (High-density polyethylene)	Low	High	Fair	Excellent	Good	Low
PC (Polycarbonate)	Medium	High	Good	Fair	Good	Low
ABS/PC	Medium	High	Good to excellent	Fair	Good	Low-medium
PP (Polypropylene)	Low	High	Fair	Excellent	Good	Low
Polystyrene (PS)	Low to medium	Low	Good	Good	Good	Low
PEEK (Polyether Ether Ketone)	High	High	Good	Fair-good	Excellent	High
PEI or Ultem (Polyetherimide)	High	High	Good	Fair	Excellent	High
PPSU (Polyphenylsulfone)	High	High	Excellent	Fair-good	Excellent	High
PA (Aliphatic Polyamides)	Medium to high	High	Fair	Good	Good	Medium
PPA (Semi-aromatic Polyamides)	Medium to high	High	Fair-good	Fair	Good	Medium-high
PBT (Polybutylene Terephthalate)	Medium	Medium	Good	Fair	Fair	Low-medium
PET (Polyethylene Terephthalate)	Medium	Medium	Good	Fair	Fair	Low-medium
LCP	High	Medium-high	Excellent	Excellent	Excellent	High
PPO	Medium	Medium	Fair-good	Good	Good	Low-medium
PPS	High	High	Good	Good	Excellent	Medium





# Materials in Detail: Part I

Resin Type	Benefits	Applications	Considerations
POM (Polyoxymethylene) or Acetal	Tough, stiff, hard, and strong. Good lubricity and resistance to hydrocarbons and organic solvents. Good elasticity, slippery. Low creep. Great fatigue properties	Gears, pumps and pump impellers, conveyor links, soap dispensers, fan and blower blades, automotive switches, electrical switch components, buttons, and knobs	Due to shrink, you need uniform wall thickness. Painting, coating, and achieving high-cosmetic finish difficult
PMMA (Polymethyl Methacrylate) or Acrylic	Good optical properties, high gloss, scratch resistant. Low shrink. Less sink in geometries with thin and thick sections	Light pipes, lenses, light shades, optical fibers, signs	Can be brittle. PC is a good alternative. Draft always required, sometimes twice as much as other materials. Poor chemical resistance
ABS (Acrylonitrile butadiene styrene)	Tough, impact- and chemical-resistant, low shrink, high dimensional stability, inexpensive	Cosmetic parts, handheld devices, housings, and moldings for electrical tools, remote controls, computers, telephone components	Show knit lines and can have sink and voids in thick areas. Reduce sink with switch to ABS/PC blend
HDPE (High-density polyethylene)	Tough, impact- and chemical-resistant, high shrink, low dimensional stability, inexpensive, density less than water (floats)	Lawn furniture, totes, containers, toys, gas cans	High shrink, low surface energy
PC (Polycarbonate)	Strong, extremely impact resistant, low shrink, good dimensional stability and heat resistance, accepts high cosmetic finishes well	Lenses, indoor and outdoor lighting, cell phone housings, electrical components, medical devices, bulletproof glass	Possible sensitivities in thick sections of parts could cause voids, bubbles, and sink. Poor chemical resistance. An ABS/PC blend is a good alternative for opaque parts with these issues. Acrylic another option for parts with thick geometries
ABS/PC	Strength, heat and low-temperature resistance, improved processing	Automotive, electronic, telecommunications	Improved thick molding and mechanical properties compared to just ABS or PC. Lower cost than PC
PP (Polypropylene)	Inexpensive, higher impact resistance in some grades, PP homopolymer can be brittle in cold. Wear resistant, flexible with high elongation. Resistant to acids and bases. Density less than water (floats)	Integral hinges or living hinges, fans, snap-over lids (e.g., shampoo bottle tops), medical pipette tubing	Thick sections in part geometry can void or show sink marks. Shrink and warp possible. If the part has living hinges that require higher stiffness, K-Resin a good alternative
Polystyrene (PS)	High optic clarity, good electric insulator	Plastic utensils, containers, optics, toys	Brittle, poor UV resistance, very susceptible to hydrocarbon solvents
PEEK (Polyether Ether Ketone)	High-temperature, high-performance, flame retardant; excellent strength and dimensional stability, good chemical resistance	Bearings, piston parts and pumps; cable insulation; compatible with ultra-high vacuum applications	High-performance material, very expensive. Ultem is a slightly less-costly option, and PPSU is worth considering if price a concern

# Materials in Detail: Part II

Resin Type	Benefits	Applications	Considerations
PEI (Polyetherimide) or Ultem	High-temperature, high-performance, flame retardant, excellent strength and dimensional stability, good chemical resistance	Medical and chemical instrumentation; tableware and catering; HVAC and fluid handling; electrical and lighting	Very expensive, though not as costly as PEEK. PPSU possible alternative
PPSU (Polyphenylsulfone)	High-temperature tolerance, dimensionally stable, high toughness. Resistance to radiation sterilization, as well as alkalis and weak acids	Medical instrument components, sterilization trays, automotive fuses, interior aircraft parts, hot water fittings, sockets, and connectors	Thick sections could result in voids, bubbles or sink. Organic solvents and hydrocarbons can also attack PPSU. Colorant cannot be added to Protolabs-supplied PPSU resins
PA (Aliphatic Polyamides)	Wide variety. High strength and temperature tolerance when reinforced. Chemically resistant except to strong bases or acids	Thin-walled features, combs, spools, gears and bearings, screws, structural parts (with glass), pump parts, under-hood components, cameras	Some nylons can be susceptible to warp due to non-linear shrink. Absorbs moisture
PPA (Semi-aromatic Polyamides)	Less susceptible to moisture than aliphatic polyamides	Automotive housings, modules, valves, sports equipment	Susceptible to warp
PBT (Polybutylene Terephthalate)	Good electrical properties for power components and works well for automotive applications. Moderate to high strength depending on glass fill. Unfilled grades are tough and flexible. Good resistance to fuels, oils, fats, and many solvents. Doesn't absorb flavors. Low creep	Slide bearings, gears and cams; coffee makers and toasters; hair dryer nozzles; vacuum cleaners; handles and knobs for electrical cookers	Glass-filled PBT resins are prone to warp, and have poor resistance to acids, bases, and hydrocarbons. Thin parts hard to fill with PBT. Nylons good alternatives
PET (Polyethylene Terephthalate)	Similar to PBT, but stiffer and higher melting point	Similar to PBT	Similar to PBT
LCP	Very easy flowing, good chemical resistance, high upper use temp, good electrical properties, low thermal expansion	Connectors, plugs, PCBs, sports equipment	Anisotropic properties and shrinkage, expensive
PPO	Good electrical insulator, hot water/steam resistance	Sensor housings, pumps, connectors	Susceptible to stress cracking
PPS	Very good chemical resistance, high upper use temp, great electrical properties	Electric components, automotive intakes, pumps, valves, sensor encapsulation	Desirable properties such as chemical resistance rely heavily on proper crystallization during molding

# Material Alternatives to Plastic Injection Molding

During material supply shortages, consider resin substitutes for ABS, PC, PP, and other commonly molded thermoplastics.

[GET GUIDE >](#)



## More Material Options and Information

We have many additional stocked resin options including PPS, TPE, TPU, LCP, HDPE, LDPE and PSU, and some resin properties can be improved by additives such as glass and carbon fiber.

## Considerations for Thermosets

We cover thermosets, and especially LSR, in the next chapter, but here's a quick overview: LSR is a common thermoset and is a useful material because of its superior flexibility and heat and chemical resistance. Typical applications include soft-touch surfaces, gaskets, and heat insulation. Molders mix two components of uncured LSR to form a relatively low viscosity "liquid rubber" solution. The material cures in the presence of heat forming a bond that can't be undone.

Some LSR materials are particularly useful for medical and optical parts. You can find detailed data sheets on these materials in our [Materials Comparison Guide](#).

A few words about thermosets and cross linking: Cross linking determines many of the characteristics of thermosets. It makes them strong, dimensionally stable, and highly resistant to heat and chemicals.

One familiar example is rubbery silicone bakeware. Cross linking lets it easily withstand a 400° oven temperature and makes it non-stick—very desirable characteristics for bakeware. However, thermosets have their liabilities as well. In harder forms, thermosetting plastics are not as impact resistant as thermoplastics and can tend to shatter.

In the end, we won't make resin choices for you, but we are always available to help you consider the specs when looking at thermoplastic versus thermoset injection molding.





# Designing for Liquid Silicone Rubber Molding

One of the most popular and flexible (pun intended) molding materials is liquid silicone rubber (LSR). LSR molding shares many similarities with conventional injection molding, but there are a few notable differences. Unlike thermoplastic resin, which is melted before injection, LSR is a two-part thermoset compound that is chilled before being injected into a heated mold and ultimately cured into a final part. Since LSR is a thermosetting polymer, its molded state is permanent—once it is set, it can't be melted again like a thermoplastic.





## LSR Characteristics

LSR is a strong, elastic material with excellent thermal, chemical, and electrical resistance. LSR parts also maintain their physical properties at extreme temperatures and can withstand sterilization. It's biocompatible, so it works very well for products that have skin contact. Those benefits lend themselves well to automotive, medical and food appliance industries, typically in the form of seals, gaskets, valves, and cables.

## Wall and Rib Thickness

Unlike other molding materials, LSR typically fills thin wall sections with minimal challenges, and walls as thin as 0.012 in. (0.305mm) are possible over smaller areas but down to 0.015 in. (0.381mm) thick over larger areas. Flow entirely depends on the size of the wall and the location of adjacent thicker sections. Rib thickness should be 0.5 to 1.0 times the adjoining wall thickness. What's great about LSR is this sort of accommodation to variations in wall thickness. Plus, sink is almost nonexistent.

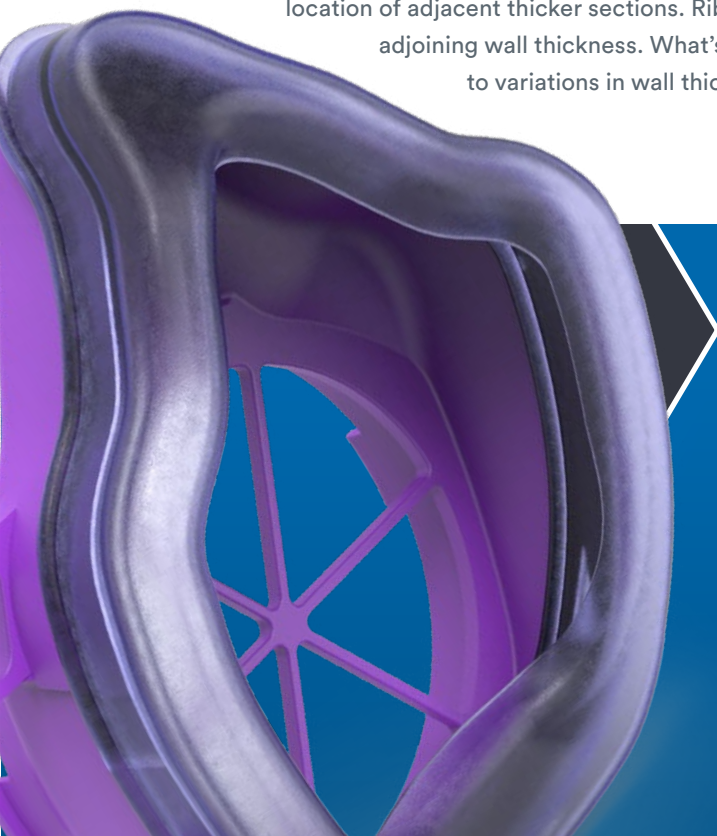

## Maximum Part Dimensions

Maximum size	12 in. x 8 in. x 4 in. (304mm x 203mm x 100mm), Depth < 2 in. (50mm) from any parting line although deeper parts are limited to a smaller outline
Maximum surface area	65.5 sq. in. (422.6 sq. cm.)
Maximum volume	26 cu. in. (426 cc)

## Shrink and Flash

The shrink rate on LSR parts is fairly high but is very consistent throughout each part, with an expected tolerance of 0.025 in./in. (0.635mm/mm) LSR also tends to flash very easily during molding in gaps as small as 0.0002 in. (0.005mm). We have ways to reduce this, though, by incorporating additional features into the mold design.

## LSR and Elastomer Materials

We carry 26 different types of LSRs and elastomers

### LSRs

- ▶ Elastosil 3003/30-80 A/B
- ▶ Silastic FL 60-9201 (Fluorosilicone)
- ▶ Dow Corning QP1-250 (Medical)
- ▶ Dow Corning MS-1002 (Optical)

### Elastomers

- ▶ Santoprene (TPE/TPV—10 varieties)
- ▶ Hytrel 3078 (TPE/TPV)
- ▶ Versaflex (TPE/TPV—four varieties)
- ▶ Texin 245 and 983 (TPU)



## Parting Lines

Simplifying and minimizing parting lines in your design will help you get cleaner LSR parts as quickly as possible. That means strategic thinking about your design is important.

## Undercuts

You can mold to accommodate parts with undercuts, which are manually removed by a press operator. We offer selective mechanical tooling actions to release undercuts. Note that LSR tends to tear fairly easily at sharp edges. In the making of interior features, it is very important to try to add fillets or radii to prevent tearing at what might be sharp edges when using a manually removed undercut.

## Overmolding and Insert Molding

LSR materials can also be used for overmolding and insert molding. In fact, LSR materials are often used for overmolding, which allows an additional layer of resin to be added to an existing molded part to provide a combination of characteristics no single material can provide.

Insert molding is used to add strength and durability to parts. Because of the high-cure temperature of LSR molding, suggested plastic materials would be Valox, PEI (Ultem), or PEEK.

Note that there usually need to be mechanical bonding features when insert molding LSR onto other parts, because LSR generally does not chemically bond.

## Part Ejection

Ejector pins are normally not used during LSR molding due to the flashy nature of the material. Thus, parts should be designed so they can be retained on one half of the mold when it is opened at the end of the molding cycle. The part is then manually removed, often with our assistance. Proper part ejection also requires that you think about the amount of draft you'll need.

## Draft

Vertical Faces	0.5°
Most Situations	2°
Minimum for Shut Off	3°
Minimum for Light Texture (PM-T1)	3°
Minimum for Light Texture (PM-T2)	5°+

## Why Use Overmolding?

One of the most common applications is to add a soft, functional, hand-friendly layer of rubber-like material, typically a thermoplastic elastomer, over a hard substrate. Another is to change or enhance the appearance or cosmetics of a part by overmolding material of a different color or finish to it. Overmolding shows up on anything from medical devices and hand tools to toothbrushes and oven knobs. Most overmolding done on these items uses TPE or TPU, rather than silicone.

# Threaded Inserts

With LSR parts, you can bolster certain pivotal points by using a brass bearing journal, a stainless steel threaded insert, or a high-temperature plastic material, among other possibilities.

Insert molding, heat staking, and ultrasonic welding provide options to insert metal parts into your injection-molded part. Insert molding adds a preformed part—often metal—during molding and works well with LSR. The other two methods are alternate ways to incorporate threaded inserts, but they are incompatible with LSR and other elastomers, so we'll cover them in the next chapter.

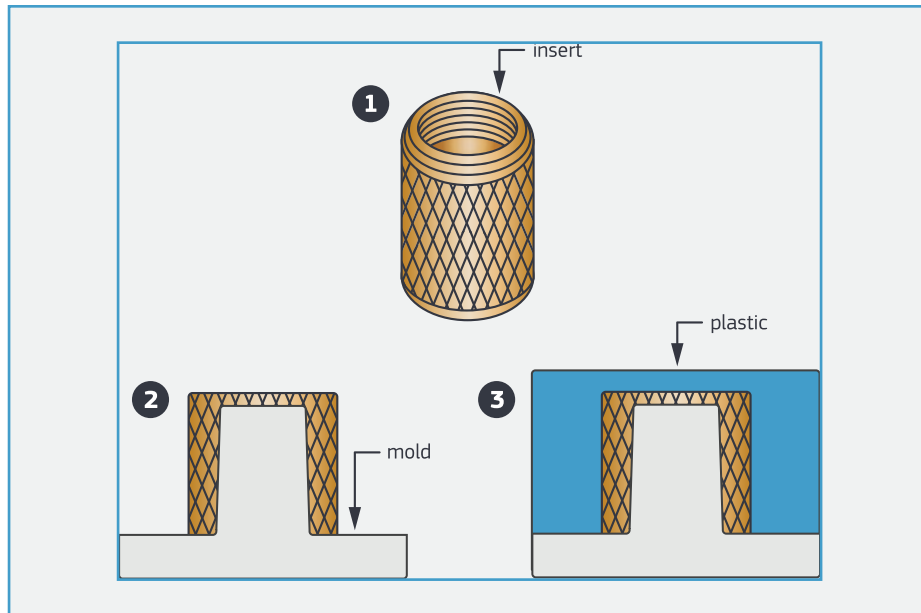

Threaded inserts can improve the structural properties of molded LSR parts.



## Stocked Threaded Inserts

### Blind-Brass Inserts (Mold-in)

INS #	Thread	Length
INS-PL0001	2-56 UNC	0.156 in.
INS-PL0002	4-40 UNC	0.205 in.
INS-PL0003	6-32 UNC	0.25 in.
INS-PL0004	8-32 UNC	0.25 in.
INS-PL0005	10-24 UNC	0.356 in.
INS-PL0006	1/4-20 UNC	0.344 in.
INS-PL0007	M3x5	5.21mm
INS-PL0008	M4x7	6.35mm
INS-PL0009	M5x8	7.13mm

### Thru-Brass Inserts (Mold-in)

INS #	Thread	Length
INS-PL0010	2-56 UNC	0.125 in.
INS-PL0011	4-40 UNC	0.187 in.
INS-PL0012	6-32 UNC	0.219 in.
INS-PL0013	8-32 UNC	0.312 in.
INS-PL0014	10-24 UNC	0.281 in.
INS-PL0015	1/4-20 UNC	0.5 in.
INS-PL0016	M3x5	4.77mm
INS-PL0017	M4x7	8.00mm
INS-PL0009	M5x8	7.13mm

# Insert Molding Capabilities

While overmolding requires two molds to create a part, insert molding is accomplished by taking a preformed part—often metal—then loading it into a mold, where it is then overmolded with plastic to create a part with improved functional or mechanical properties. We currently accept inserts from PEM, Dodge, Tri-Star, Spirol, and Tappex. A complete chart of [stocked inserts at Protolabs is available here](#).

Insert molding lets threaded inserts reinforce a plastic part's ability to be fastened together, especially over repeated assembly. Bushings and sleeves are another great way to increase part durability for mating components that need more abrasion resistance due to moving parts.

# Bonding Overmolding Materials

Chemical bonding between overmolded materials is possible, but material compatibility should be considered to achieve desired bond strength. Incorporation of an adequate mechanical bond is strongly recommended if bonding is critical to your application, an undercut, for example. The following table offers up the compatibility information you need for many of your parts.



## Substrate Material

Overmold Material	ABS Lustran	ABS/ PC Cycloy C2950-111	PC Lexan 940-701	PBT Valox 357-1001	PP Profax 6323
TPU - Texin 983-000000	C	C	C	C	M
TPV - Santoprene 101-87	M	M	M	M	C
TPE - Santoprene 101-64	M	M	M	M	C
LSR - Elastosil 3003/30 A/B	-	-	M	M	-
TPC - Hytrel 3078	C	C	C	C	M
TPE-Versaflex OM 1060X-1	C	C	C	M	M
TPE-Versaflex OM 6240-1	M	M	M	M	M
TPE-Versaflex OM 6258-1	M	M	M	M	M
TPE-Versaflex OM 1040X-1	C	C	C	M	M

M = Mechanical Bond (recommended)

C = Chemical Bond



# Finishing Options for Molded Parts

Some say that a part isn't complete until it's been through finishing. Whether you choose something that changes the aesthetics, strengthens parts, or adds customization, knowing your options can take an ordinary design and make it extraordinary.

# Mold Texturing and Mold-Tech™-Equivalent Finishing

There are several reasons to choose mold texturing for your parts. Perhaps you like the appearance of a regular pattern, like a bead-blasted matte finish? Or maybe you need for your parts to have a functional texture, such as adding a bit of friction to help make them easier to hold. One example is the texture of a car's steering wheel which helps prevent it from sliding through your fingers as you turn. An additional advantage of having a textured surface is that it often allows you to add paint—providing a stickier surface to bond with.

We offer a standard set of texturing options, which include our ProtoMold (PM) and Society of Plastics Industry (now called the Plastics Industry Association, but still referred to as SPI) standards, which are noted in this chart.

Finish Callout	Description
PM-FO	Protolabs' texture; non-cosmetic; finish to Protolabs' discretion
PM-F1	Protolabs' texture; low cosmetic; most tool marks are removed
PM-F2	Protolabs' texture; non-cosmetic; EDM permissible
SPI-C1	600 grit stone
SPI-B1	600 grit paper
SPI-A2	Grade #2 diamond buff
PM-T1	Protolabs' texture; light bead-blast
PM-T2	Protolabs' texture; medium bead-blast

Mold-Tech equivalent finishes are available. These use chemical etching or laser-based modification of the mold cavity. Each is represented by an MT- followed by a five-digit code. For example, MT-11010 presents a sand-like appearance, MT-11120 resembles smooth concrete, while MT-11555 has a wood panel look, and so on. There are literally hundreds of Mold-Tech equivalent options available.

## How We Add Texture to Molds

Two distinct processes are available, but which one to use depends on the type of finish, its surface depth, and the mold material. Regardless, both are applied after the mold cavities have been completely machined and their soon-to-be-textured surfaces smoothed to the requisite level. For light texturing, a corrosive chemical is applied in a controlled manner, etching the mold cavity until the desired depth and appearance are reached. If certain surfaces are not going to be textured, those areas are masked off with protective tape beforehand. This option is available as a special order Mold-Tech equivalent finish.

## Rules for Aggressive Textures

Another Mold-Tech equivalent finish creates geometric textures such as checkerboards and diamond patterns (think flashlight handles). For this, a five-axis laser is typically used to burn off mold material. Some textures may reach depths of more than 0.003 in. (0.0762mm), which means you need larger draft angles to ensure parts release cleanly from the mold. Generally, we recommend one degree of draft for every 0.0005 in. to 0.0006 in. (0.0127mm to 0.0152mm) of texture depth, or roughly 6 to 7 degrees for a typical wood grain or leather-like finish. The DFM analysis that accompanies your online quote will help guide you.

## Materials

We don't recommend textured surfaces on soft polymers such as TPE and LSR, as these don't pick up the finish very well. Nor does texturing add much cosmetic value with white or transparent materials like polycarbonate, except in those cases where the texture may serve to diffuse light or provide other optical properties. There are exceptions, but in most cases, texturing provides the best cosmetic results in darker materials.

Finally, take special care when using fiber or flame-retardant polymers with textured molds because the resins don't flow as readily as other materials. Glass fibers, for instance, can add a stringy or sparkly finish to a textured part, while flame retardants might lead to the whitish streaks known to plastic injection molders as splay.



# Threaded Inserts

As mentioned in the last chapter, there are three ways to incorporate threaded inserts into your molded part: insert molding, heat staking, and ultrasonic welding. The latter two methods are finishing options only appropriate for rigid thermoplastics and not elastomers and thermosets. Here are the very high-level differences between those two methods: Heat staking uses a conductive surface to generate heat. Ultrasonic welding uses high frequency vibrations to generate heat and drive the insert into the part.

The latter two are post-processing options used to add inserts to thermoplastics to support different—and often, more complex—geometries. We stock and install an assortment of commonly used standard inserts in UNF and metric sizes.

## Tapered Inserts (Heat Stake/Ultrasonic)

Inch		Metric		A	B	C	D	E	F	Min. Boss
Thread Size	Part Number	Thread Size	Part Number	± 0.004 in. (long)	± 0.004 in. (short)	± 0.004 in.	± 0.004 in.	0.002 in.	0.002 in.	
2-56	256 x 115H	M2.0 x 0.4	M20 x 115H		0.115 in.	0.123 in.	0.141 in.	0.129 in.	0.118 in.	0.246 in.
	256 x 188H		M20 x 188H	0.118 in.		0.112 in.	0.141 in.	0.123 in.	0.107 in.	0.246 in.
4-40	440 x 135H	M2.5 x 0.45	M25 x 135H		0.135 in.	0.157 in.	0.172 in.	0.159 in.	0.153 in.	0.318 in.
	440 x 219H		M25 x 219H	0.219 in.		0.146 in.	0.172 in.	0.159 in.	0.141 in.	0.318 in.
6-32	632 x 150H	M3.5 x 0.6	M35 x 150H		0.150 in.	0.203 in.	0.219 in.	0.206 in.	0.199 in.	0.412 in.
	632 x 105H									
8-32	832 x 185H	M4.0 x 0.7	M40 x 185H		0.185 in.	0.230 in.	0.250 in.	0.234 in.	0.226 in.	0.468 in.
	832 x 312H		M40 312H	0.3127 in.		0.213 in.	0.250 in.	0.234 in.	0.208 in.	0.468 in.

# Threaded Inserts Without Insert Molding

Applications for threaded inserts in injection-molded parts abound. They are common features that show up in a range of industries and in a variety of parts—housings, casings, electronic enclosures, appliance knobs and dials, etc. If insert molding is not an option for your design, you can use either heat staking or ultrasonic welding. Both options offer tightness, durability, and aesthetics for plastic parts. Here's a quick comparison:

## Heat Staking

This method involves heating threaded inserts and press fitting them into part geometries. This requires precise control and application of the temperature and pressure to cause the reforming of the plastic. Heat staking is commonly used in the manufacturing of appliances, automotive parts, and components and equipment for the telecom industry.



## Ultrasonic welding

This process is typically used for plastics. Its localized, high-frequency acoustic vibrations heat the plastic, allowing a press fit into part geometries, creating a solid-state weld. You'll see this process used for parts in medical devices, automotive parts, aerospace components, and electronic assemblies. We stock and install an assortment of commonly used standard inserts in UNF and metric sizes, but currently we are unable to accept user-supplied custom inserts.

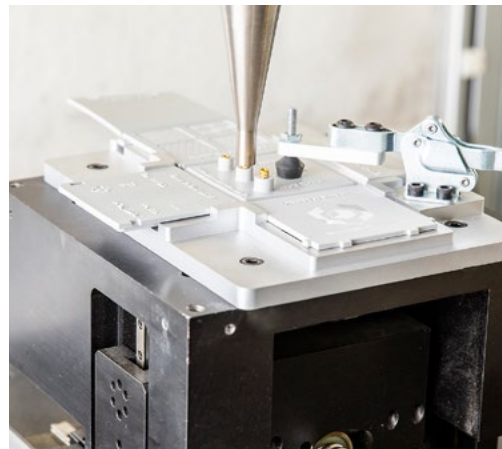

## Pad Printing

Pad printing transfers a two-dimensional image, such as a company logo, onto a three-dimensional object. You'll see items marked with pad printing everywhere: household appliances, consumer electronics, buttons and keys on computer keyboards, toys, golf balls, and so on. All images are reviewed for size, color, and complexity restrictions. Also, images for printing should be provided with locations clearly marked in reference to part geometry. PM-T1 and MT11010 are the most aggressive textures we can pad print. Note that pad printing at Protolabs typically adds 3+ business days to your parts order.

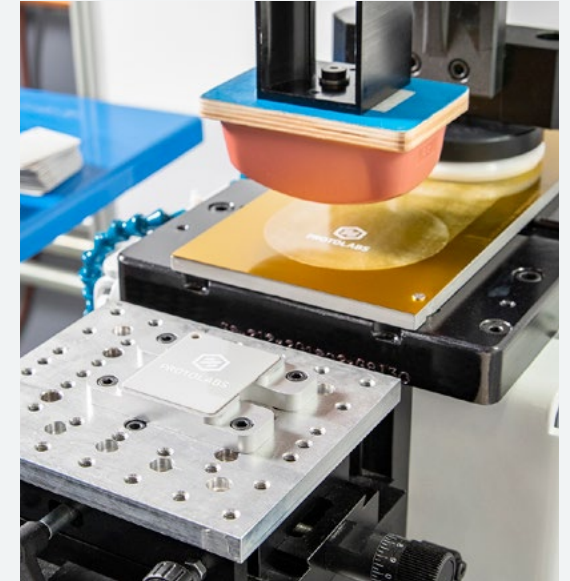

## Laser Engraving

Laser engraving is an option available for part marking. It is applied to the mold or directly to parts and lets you add information such as logos, serialization, or part numbers. Laser engraving ensures crisp, consistent information on each part. Note that acetals and high temperature materials are not suitable for laser engraving, and that the process typically adds 4+ business days to your parts order and, 9+ business days to your mold order.

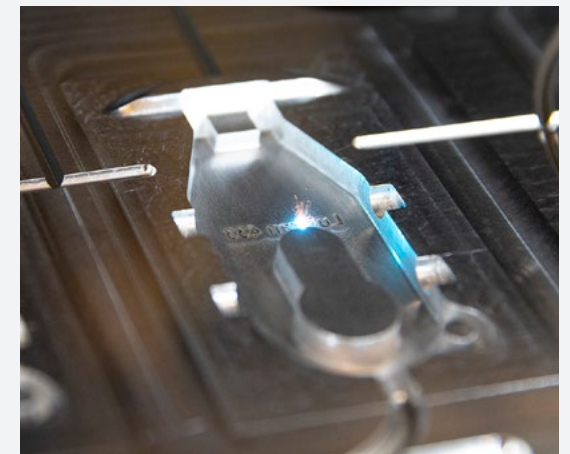

## Basic Assembly

Our basic part assembly options include fastening parts together that we have manufactured and/or applying labels to individually bagged parts. We are not able to accept customer-supplied parts for assembly at this time. Assembly typically adds 3+ business days to your order.

## Kitting/Packaging/Labeling

This service involves creating a parts kit, specialized packaging, and/or labeling, which can be used as an input to fulfill manufacturing jobs or sent to a customer as a completed product. Lead time is typically 3+ business days to your parts order.



## Finishing Options: Required Inputs

Mold Texturing	<ul style="list-style-type: none"><li>▶ CAD/part link</li><li>▶ 2D drawing/image with faces to be textured</li><li>▶ Desired texture (e.g., MT 11010)</li></ul>
Pad Printing	<ul style="list-style-type: none"><li>▶ CAD/part link</li><li>▶ 2D drawing noting location of graphics</li><li>▶ Adobe Illustrator file noting size of graphic</li><li>▶ Part quantity</li><li>▶ Material: Only ABS, PC, ABS/PC are available</li><li>▶ Color specification (PANTONE® #)</li></ul>
Laser Engraving	<ul style="list-style-type: none"><li>▶ Drawing or CAD identifying size</li><li>▶ Location and depth of engraving</li><li>▶ Part quantity, if applicable</li><li>▶ Material</li></ul>
Threaded Inserts (Heat Staking, Ultrasonic Welding)	<ul style="list-style-type: none"><li>▶ CAD/part link</li><li>▶ 2D drawing noting insert type and location</li><li>▶ Assembly CAD, if possible</li><li>▶ Part material, quantity</li></ul>
Basic Assembly	<ul style="list-style-type: none"><li>▶ CAD/part link</li><li>▶ Assembly drawing or CAD</li><li>▶ Part quantity</li></ul>



# Process Controls, Quality Assurance, and Reporting

Earlier in the guide, we talked about Critical-to-Quality (CTQ) quoting. It's just one of the ways that we help you rest assured that the parts you order are consistent with your model.



To remind you, the idea with CTQ is a simple one: You mark up to five dimensions that are critical to the success of your part with a red circle. You can also designate others in blue that are important, but not mandatory for the part. This lets us know to keep an eye on certain features.

Even better, because we use [scientific molding](#) techniques, each step in the injection molding process is independently optimized to maximize part quality, and then documented digitally. That means when you submit an additional order for the same parts, we can follow those steps to manufacture consistent parts that adhere to your CTQ specifications.

If part quality and accelerated sample qualification are prime considerations for you, CTQ lets you say upfront what you think is most critical in your parts, and what is of secondary importance.



## Review Your Inspection Statement of Work

Once you submit your model, our applications engineering team will review it and email you an Inspection Statement of Work (ISOW), which lets you know if any features you circled have issues with tolerances and moldability. Once we send the ISOW, we manufacture and inspect your order at Protolabs speeds.

## View Report on Your Final Parts

After we have completed molding process development, which ensures we have a consistent and repeatable process to produce quality parts, we will inspect the first three shots from the tool using a Coordinate-measuring Machine (CMM), hand caliper, or pin gauge and provide you with a First Article Inspection (FAI) report.

The CTQ FAI will measure all critical and reference dimensions. Leveraging the same CMM, we will inspect another 30 parts from the order and produce the CTQ Capability Report.

Parts will be measured at an equidistant cadence of  $n/30$  where  $n$  = total part order quantity. Along with the measurement data from each part, the Capability Report will also provide the average measurement, standard deviation, and a Process Capability Index (Cpk) value for all critical dimensions.

①	②	Position	CMM	0.0000	Reference
Position	Distance	CMM	0.0000	+0.0100 / -0.0400	0.0000
CMM	1.2004	Reference Only	0.7755		0.0000
0.0000	+/- 0.0055	0.0023	0.7784		0.0000
Reference Only	1.1974	0.0002	0.7784		0.0000
0.0022	1.2002	0.0004	0.7784		0.0000
0.0042	1.2000	0.0003	0.7784		0.0000
0.0037	1.2001	0.0003	0.7784		0.0000
0.0037	1.2022	0.0005	0.7758		0.0000
0.0159	1.2002	0.0011	0.7758		0.0000
		0.0029	0.7767		0.0000



# Why Use CTQ?

When you use CTQ, you get these advantages:

- ▶ In-process quality feedback at the press with no effect on lead time
- ▶ Reduction in cost and time by eliminating in-house measurements
- ▶ Receive a dimensional report to validate samples
- ▶ Gain critical design and material performance lessons for current and future iterations
- ▶ Improved part accuracy and dimensional adherence on customer-specified critical dimension(s)

The bottom line is that you need parts that work effectively in your application and you know how each part, like a puzzle piece, fits into that schema. Letting us know the most important features ensures that you'll get your parts back fast with the accuracy and reliability you expect. Plus, if you need other reports, our on-demand manufacturing has you covered.

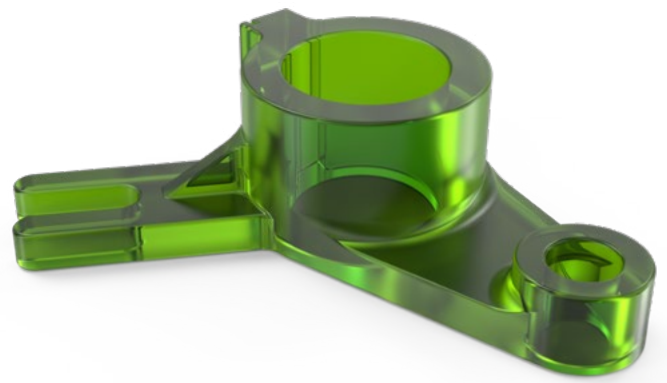

**RESULTS: SUMMARY TABLE**

Characteristics	Position	Dimension	Position	Dimension	Position
Customer	CMV1	CMV2	CMV1	CMV1	CMV1
Material	0.0000	1.2004	0.0000	0.7814	0.0000
Production Quantity	Minimum Qty: 1000000				
Part #1	0.0002	0.0002	0.0002	0.0002	0.0002
Part #2	0.0002	0.0002	0.0002	0.0002	0.0002
Part #3	0.0002	0.0002	0.0002	0.0002	0.0002
Part #4	0.0002	0.0002	0.0002	0.0002	0.0002
Part #5	0.0002	0.0002	0.0002	0.0002	0.0002
Part #6	0.0002	0.0002	0.0002	0.0002	0.0002
Part #7	0.0002	0.0002	0.0002	0.0002	0.0002
Part #8	0.0002	0.0002	0.0002	0.0002	0.0002
Part #9	0.0002	0.0002	0.0002	0.0002	0.0002
Part #10	0.0002	0.0002	0.0002	0.0002	0.0002
Part #11	0.0002	0.0002	0.0002	0.0002	0.0002
Part #12	0.0002	0.0002	0.0002	0.0002	0.0002
Part #13	0.0002	0.0002	0.0002	0.0002	0.0002
Part #14	0.0002	0.0002	0.0002	0.0002	0.0002
Part #15	0.0002	0.0002	0.0002	0.0002	0.0002
Part #16	0.0002	0.0002	0.0002	0.0002	0.0002
Part #17	0.0002	0.0002	0.0002	0.0002	0.0002
Part #18	0.0002	0.0002	0.0002	0.0002	0.0002
Part #19	0.0002	0.0002	0.0002	0.0002	0.0002
Part #20	0.0002	0.0002	0.0002	0.0002	0.0002
Part #21	0.0002	0.0002	0.0002	0.0002	0.0002
Part #22	0.0002	0.0002	0.0002	0.0002	0.0002
Part #23	0.0002	0.0002	0.0002	0.0002	0.0002
Part #24	0.0002	0.0002	0.0002	0.0002	0.0002
Part #25	0.0002	0.0002	0.0002	0.0002	0.0002
Average	0.0000				
Std. Dev.	0.0000				
CV	0.0000				
CPK	0.0000				

**RESULTS: CONTROL CHARTS**

# How GD&T Helps

When you submit a 3D CAD model to us, it gives us a strong indication of the specs for your part. Geometric Dimensioning and Tolerancing (GD&T) takes it even further, providing us with acceptable deviations to your geometries. Specifically, you can provide us with the following GD&T data for features in your model:

- ▶ Position
- ▶ Flatness
- ▶ Straightness
- ▶ Circularity
- ▶ Parallelism
- ▶ Perpendicularity
- ▶ Concentricity
- ▶ Cylindricity
- ▶ Profile of a Surface



# Prototyping to Production

Taking you through your part's life cycle

# Prototyping or On-Demand Manufacturing?

We make it easy for you to work with us from prototyping through production. Using scientific molding techniques, we optimize your parts for production and monitor them in real-time via our machine connectivity network, saving you time and simplifying process qualification across your development stages. Every step in our process is documented as a data point and that knowledge is applied to each run of your parts. Along the way, we offer DFM feedback and design consultation to improve part design, and in-process CMM inspection to verify critical dimensions and help you qualify parts and process quickly. Finishing options? We have a range of those, too, including Mold-Tech equivalent finishes!

Still not sure which service is right? [Get quotes for both to compare.](#)

	Prototyping	On-Demand Manufacturing
Objective	I need to validate my design at Protolabs speeds. I need the flexibility to economically iterate before production	I have on-demand production needs at Protolabs speeds.
Best When	<ul style="list-style-type: none"> <li>▶ Completing design or material iterations and assessing cost or manufacturability tradeoffs</li> <li>▶ Key focus is to reduce design risk, increase R&amp;D productivity, and iterate faster to reduce time to market</li> <li>▶ Typical quantities &lt;2,000</li> </ul>	<ul style="list-style-type: none"> <li>▶ Design is finalized, and run-to-run part consistency is critical</li> <li>▶ Key focus is to improve quality, reduce cost, and mitigate supply chain risk</li> <li>▶ Process development, qualification documentation, and mold capability information are required</li> </ul>
Mold Cavities	Single	Single and multi-cavity
Mold Life	Limited (guaranteed for at least 2,000 shots)	Unlimited
Mold Storage	Stored for 18 months of inactivity	Stored for 3 years of inactivity
Mold Ownership	Upon request	Yes
Quality Documentation	Basic inspection reports available upon request	<ul style="list-style-type: none"> <li>▶ Scientific Molding process development report</li> <li>▶ In-process CMM inspection of critical dimensions, including 9 GD&amp;T symbols</li> <li>▶ First Article Inspection (CTQ)</li> <li>▶ 30 part capability study (CTQ)</li> <li>▶ PPAP, IQ/OQ/PQ, ISO13485 and more through our trusted partners</li> </ul>
Shared Features	Aluminum molds   Standard lead times as fast as 7 days   Tolerances of +/-0.003 in. (0.076mm) plus resin tolerance (in./in.) Set-up fees apply to each run   Consultative Design Services (CDS)   Finishing options No minimum order quantities (MOQ)   Quick-turn shipping in as fast as 1 day	

\*Inspection conducted on initial run of parts

# Why Use On-Demand Manufacturing?

Start with advanced design for manufacturability feedback, which ensures that your design is optimized before a single part is molded. From there, our scientific molding process generates data and lessons learned and applies them to each run of your parts. Our in-process CMM inspection ensures and verifies dimensional consistency throughout the manufacturing process, and we finish with a 30-part capability study to verify your critical dimensions.

Our on-demand manufacturing service helps you simplify your supply chain so you can get quality parts easier and faster. We meet your inventory needs with no minimum order quantities, and offer supply chain flexibility ranging from bridge tooling and just-in-time (JIT) production to standard production and dual-sourcing strategies. So, you get:

- ▶ Free prototype mold when upgrading to on-demand manufacturing
- ▶ No minimum order quantity
- ▶ Scientific molding process development report
- ▶ In-process monitoring and inspection
- ▶ First article inspections and process capability study with GD&T
- ▶ ISO 9001:2015; ISO 13485; CoC; CoA



Taking it to the next level, this chart shares the potential cost savings you can achieve with on-demand manufacturing for molded parts with varying levels of complexity.

Part Complexity	Simple	Medium	High
Extents	1 in. x 1 in. x 0.65 in.	3.5 in. x 2.5 in. x 1 in.	4.2 in. x 4.2 in. x 2.9 in.
Part Volume	0.16 in. <sup>3</sup>	2.73 in. <sup>3</sup>	7.31 in. <sup>3</sup>
Piece-Part Pricing			
Prototype Single-Cavity Mold	\$1.50	\$2.45	\$7.50
On-Demand Manufacturing Single-Cavity Mold	\$1.00	\$1.70	\$5.30
On-Demand Manufacturing Multi-Cavity Mold	\$0.40	\$0.85	\$2.00

Note that this is just an example to illustrate the potential piece-part price savings offered by on-demand manufacturing.



[Upload a 3D CAD model](#) today for an interactive quote with manufacturing analysis—within hours.



# Why Injection Molding at Protolabs?



Earlier in this guide, we mentioned that the concept of injection molding isn't incredibly complex. Making that process fast and cost effective, while continuing to deliver reliability, quality, and repeatability is a little more challenging. As you leave this guide and go on to knock it out of the park on your next molding project, here are some things to keep in mind:

## Automation

Understanding that the Protolabs process relies entirely on software, automation, and standardization is key to understanding how to best leverage our services, all the way through production programs. From the moment you upload a CAD model, we're creating a digital twin of your part to predict challenges you might face down the road and correct them in design. This same automation is what enables our speed, cost-effective services, and reliability.

## Speed

When you need parts fast, we can cut a new mold and deliver parts in as little as one business day. When you don't need them quite as fast, we deliver as fast as 7 days standard.

## Cost

Cost is a very important factor, and many of our customers value cost-effective tooling just as much as speed, depending on their unique strategies. Our robust aluminum tooling delivers an affordable option, while maintaining the quality needed for production programs.

## Reliability

Scientific molding processes, automated in-line CMM inspection, FAI, and capability studies are just some of the in-process safeguards that we use to ensure high quality parts. This gives you peace of mind that you'll have what you need when you need it, but it also gives you flexibility to react to unforeseen circumstances.

Thank you for taking the time to read through this guide! If you're ready to speak with someone about your next project, please reach out to one of our applications engineers who are always available to help at [877-479-3680](tel:877-479-3680) or [customerservice@protolabs.com](mailto:customerservice@protolabs.com).

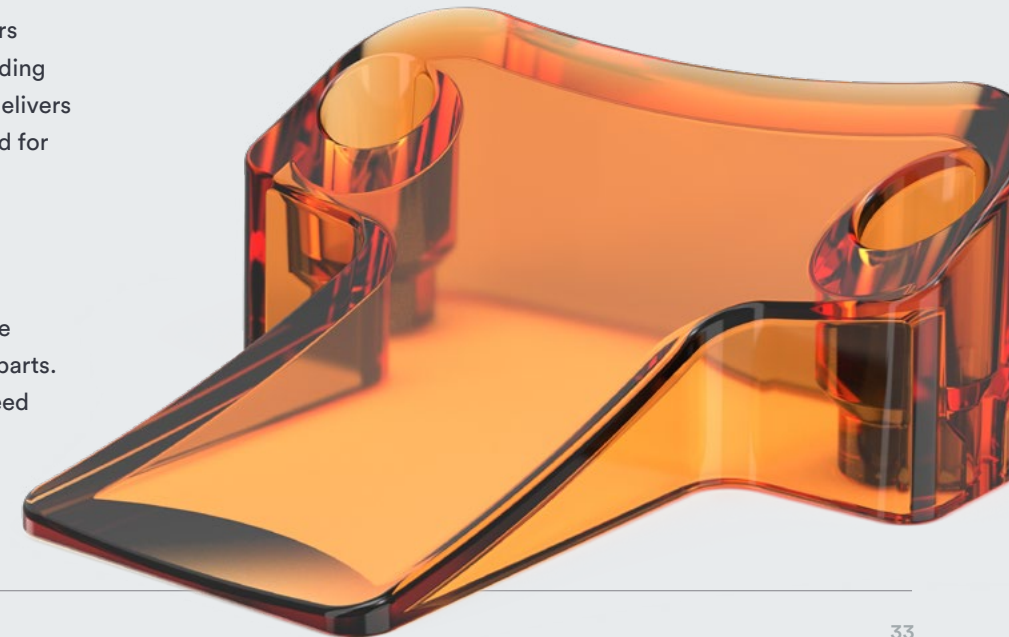





## Contact Us

5540 Pioneer Creek Dr.  
Maple Plain, MN 55359  
United States

**P** 877-479-3680

**F** 763-479-2679

**E** [customerservice@protolabs.com](mailto:customerservice@protolabs.com)



**Upload a 3D CAD model** today for an interactive quote with manufacturing analysis—within hours.

